

CAAG Report

To: Conservation Area Advisory Group

From: Sarah Leete-Groves (Specialist Advisor (Conservation))

Date: Tuesday 24 May 2016

Sensitivity: Normal

Subject: Windows: A guide to their maintenance, repair and replacement

Purpose of Report:

- To provide a summary of the current policies and guidance available to assess the replacement of windows through the planning process.
- To seek Members views on the draft window guidance document which; amalgamates current national guidance, available on windows and identifies the relevant national and local policies and supplementary guidance, referred to as part of the planning process when assessing the replacement or renewal of windows.

Recommendations and requirements of CAAG:

- That Members provide their comments on the report

1.0 Introduction

1.1 It has become apparent in determining applications for the replacement of windows through the planning process that EBC has little guidance available relating to the maintenance, repair, replace and aesthetic value associated with traditional windows.

1.2 This is further emphasised through the number of planning applications received for the replacement of traditional timber windows with uPVC units and their unauthorised replacement, which suggests that there is a lack of awareness of the merits associated with traditional windows. A case in point being a recent enforcement decision against the unauthorised replacement windows to Eastbeach Hotel, a seafront hotel identified as being a building of local interest sited in a conservation area.

2.0 Background

- 2.1 Following discussions between Councillors and the Eastbourne Hospitality Association, it was decided that a review of the approach in respect of UPVC windows in Conservation Areas should be undertaken.
- 2.2 This document has been produced to provide owners, agents, applicants and other interested parties with an insight into the heritage values attached to the significance of traditional windows, as they would be assessed by EBC, through the planning process. In addition, advice on good practice is offered for the maintenance and repair of traditional windows including their wholesale replacement.

3.0 Existing Policy

- 3.1 It is important to note that EBC does not have a dedicated planning policy which relates specifically to the renewal or replacement of windows. However, replacement windows that require approval through the planning process are considered in accordance with the relevant policies and adopted guidance.
- 3.2 Existing national policy comes from the National Planning Policy Framework [NPPF] Section 12, which highlights the need for both the applicant and local planning authority to identify the significance of the heritage asset subject to alteration, with weight given to the harm of the identified significance through the proposed alteration.
- 3.3 A key element of significance is design, which is assessed on a local level through Policy D10a: Design, found within the Core Strategy Local Plan 2013, which seeks to achieve a high quality environment where new development makes a positive contribution to the appearance of our townscape and urban heritage.
- 3.4 The assessment of urban heritage is found in Core Strategy Policy D10 Historic Environment. This policy supports the protection and enhancement of all significant heritage assets, where practicable. There is a presumption in favour of protection of all heritage assets from inappropriate change, including both designated (Listed Buildings, Conservation Areas) and non-designated assets (Buildings of Local Interest and Areas of High Townscape Value).
- 3.5 In addition, Policies UHT15, UHT16, UHT17 and UHT18, found within the Eastbourne Borough Plan 2001-2011 (adopted 2003, saved 2007) further define the value EBC attaches to both designated and non-designated assets through development management policies.

- 3.6 In support of the identified Borough Plan Policies, the adopted Eastbourne Townscape Guide (2004) Guidelines WD1, WD2 and WD3 specifically relate to replacement windows. This Supplementary Planning Guidance has been tested through the development management and appeal process.

4.0 Contents of Draft Guidance

- 4.1 In general the draft window guidance document is an amalgamation of national guidance available on the maintenance, repair, replacement and significance of traditional windows. In addition the document highlights the importance of design and highlights both national and local policies including supplementary planning guidance, which are to be considered as part of the planning process when assessing replacement windows in listed buildings, conservation areas, buildings of local interest and areas of high townscape value.
- 4.2 To assist with determining what constitutes the maintenance, repair or replacement of windows through the planning process, a window assessment flowchart of frequently asked questions and a planning process flowchart for replacement windows, has been included within the document.
- 4.3 As a starting point the document highlights the merits associated with a regular maintenance program of cleaning and painting. An approach which will extend the life of a window, besides being more cost effective than installing new windows.
- 4.4 Where repair is required to overcome decay in the frame; the document advised where feasible, the window should be repaired in situ, retaining, as much fabric as possible, which in turn goes towards conserving the visual character and appearance of the building and the contribution it makes, to the immediate and wider area.
- 4.5 In considering the replacement of traditional windows, the document identifies and highlights what constitutes the key components (detailing) of a window that make it significant. Key components that contribute to the buildings original design intent which makes a historic and or architectural contribution to the significance of the building and or area.
- 4.6 In addition the document, offers further advice, on internally fitted secondary glazing units which can be an effective measure, to reduce noise and heat loss.

5.0 Next Steps

- 5.1 Following consideration and comments from Conservation Area Advisory Group [CAAG], the draft windows guidance will be presented to Planning

Committee on 26 July for their comments.

- 5.2 A review of the Tourist Accommodation Retention policy is being undertaken at the same time as the Windows Guidance, and both documents will be presented to Planning Committee on 26 July for their comments. Following this, both reports will go to Cabinet on 16 September for authority to publish for a six week consultation period. Following the consultation period, the result of the consultation and any proposed amendments will be presented to Local Plan Steering Group and Planning Committee before going to Cabinet and Full Council for adoption in February 2017.

6.0 Conclusion

- 6.1 Whilst there is not a planning policy that specifically relates to the replacement of windows, the existing policies and supplementary planning guidelines have been successfully tried and tested at appeal, demonstrating EBC existing policies in relation to design and heritage are adequate when dealing with the renewal or replacement windows through the planning process.
- 6.2 There is no absolute answer to whether UPVC windows are acceptable in Conservation Areas and each case will be judged on its merits, but it is anticipated that the draft guidance will provide a clearer understanding on the assessment of windows through the development management process and address issues of inconsistency.
-

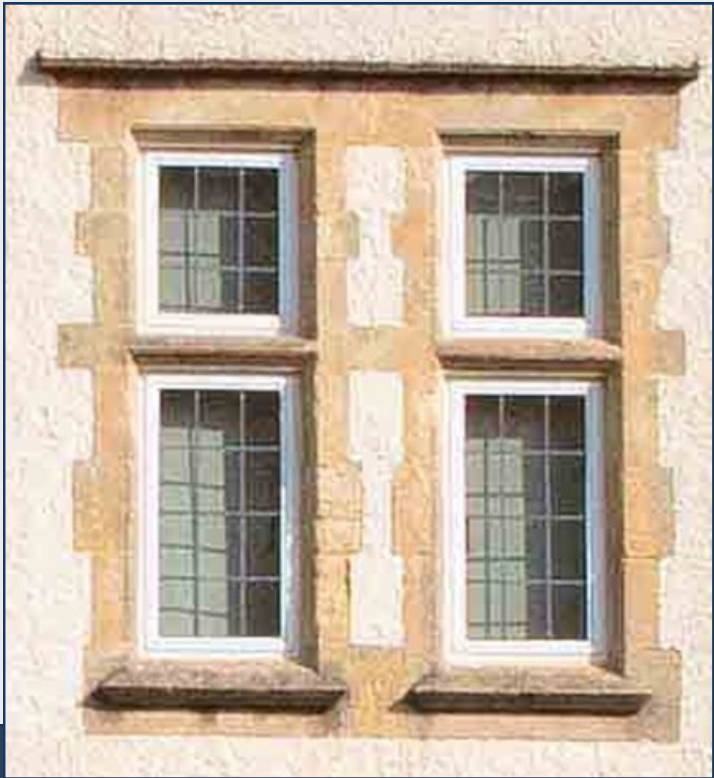

Windows

A guide to their
maintenance, repair and replacement



Windows
**A guide to their maintenance, repair and
replacement**

Eastbourne Borough Council
1 Grove Road, Eastbourne
East Sussex, BN21 4TW

Tel: (01323) 410000

Fax: (01323) 415130

Minicom: (01323) 415111

Email: customerfirst@eastbourne.gov.uk

Date: First Published: April 2015

Available to view on-line at:

www.eastbourne.gov.uk/ the by following the planning policy link to
Conservation.

Table of Contents

Introduction	3
Window assessment flowchart (A)	4
The planning process flowchart (B)	5
Windows in context... ..	6
Section 1: Maintenance of Windows	8
Timber Windows.....	8
Metal Windows.....	8
Section 2: Repair of Windows	12
Timber Windows.....	12
Metal Windows.....	13
Section 3: Replacement Windows	16
Detailing	16
Material.....	17
Section 4: Thermal Upgrading.....	20
How can thermal properties of single glazed windows be upgraded.....	20
Draught proofing	20
Secondary glazing	21
Section 5: Planning Legislation	24
Listed Buildings	27
Conservation Areas.....	30
Local Heritage Assets (Buildings of Local Interest & Areas of High Townscape Value).....	32
Building Regulations	34
Section 6: Significance.....	36
<i>Overview.....</i>	<i>36</i>
Heritage Values	37
Appendix 1.....	40
A brief history of windows	40



Appendix 2..... 52
 Glossary..... 52

Reference 58

Introduction

One of the biggest threats to the aesthetic value of a building or area is the inappropriate change or replacement of its traditional windows. Whilst this threat is attributed to different sources, the most common is the introduction of plastic windows (uPVC).

In response to the ad-hoc erosion of the aesthetic merits attached to the character of the built environment, through the introduction of inappropriate windows, this guidance has been produced to provide owners, agents, applicants and other interested parties with an insight into the heritage values attached to the significance of traditional windows as they would be assessed by the Local Planning Authority, through the planning process.

In addition, more practical advice on good practice is offered for the maintenance and repair of traditional windows including their wholesale replacement.

To assist with determining what constitutes the maintenance, repair or replacement of windows through the planning process, a window assessment flowchart of frequently asked questions and a planning process flowchart for replacement windows, has been included.



Fig. 1
Timber ledged light
The Park Close Conservation



Fig. 2
Traditional timber sash
Upperton Conservation Area

Window assessment flowchart (A)

FREQUENTLY ASKED QUESTIONS

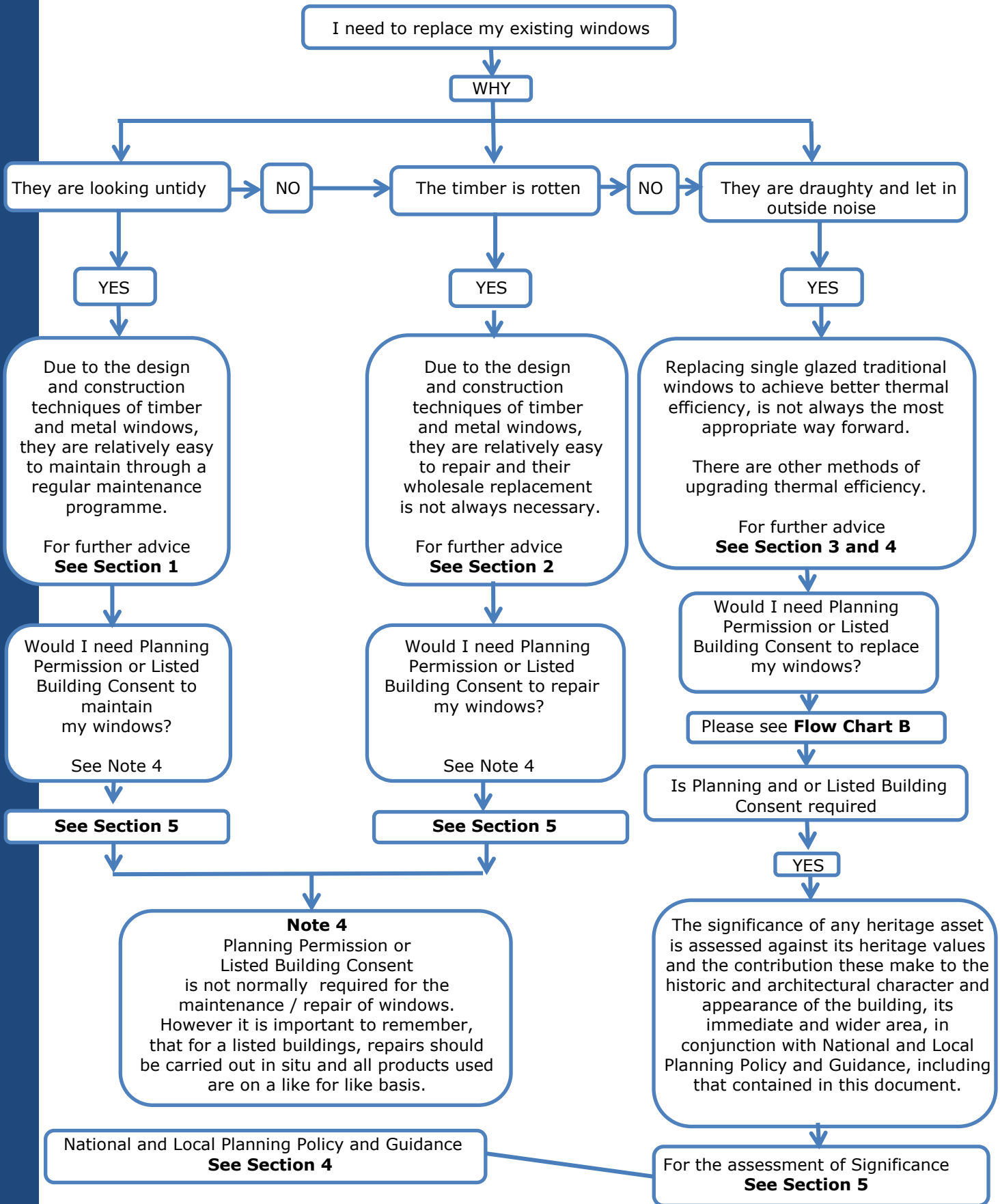

The planning process flowchart (B)

For Replacement Windows

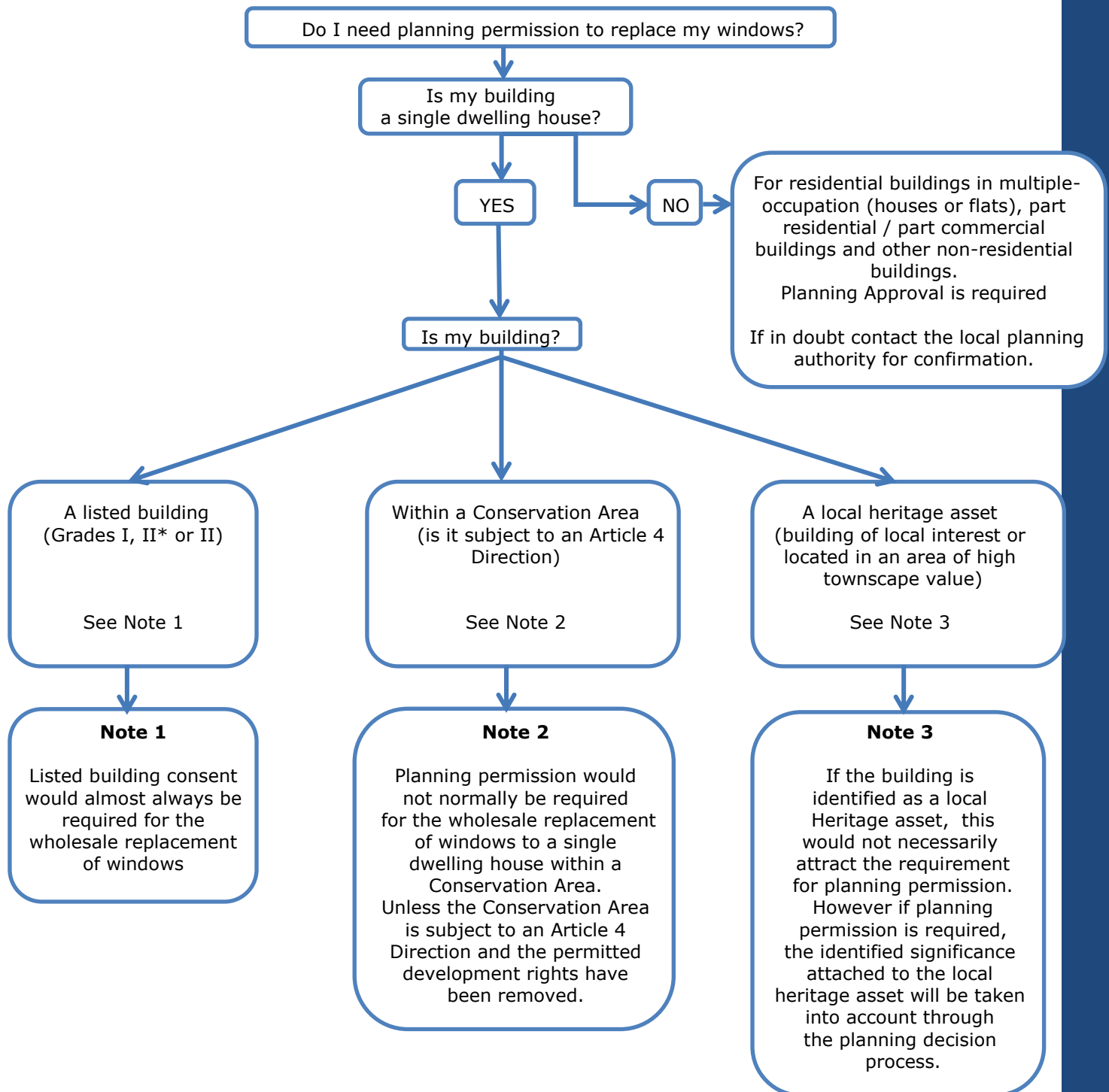

If in doubt please contact the local planning authority for confirmation.

NOTE
The significance of any heritage asset is assessed against its heritage values and the contribution these make to the historic and architectural character and appearance of the building, its immediate and wider area, in conjunction with National and Local Planning Policy and Guidance, including that contained in this document.

Windows in context...

In Eastbourne the vast majority of windows that contribute to the historic and architectural character and appearance of the Borough, comprise of two opening types: hinged casements and sliding sashes. Those that don't open are known as fixed lights. All of which are traditionally constructed in either metal (in the form of wrought iron, cast iron, steel or aluminium) or timber.

Regardless of the use of material or mechanism for opening, aesthetically the proportions, detailing and glazing pattern of windows are imperative to the integrity of the building's significance.

Hinged casement and fixed lights



Left: Top hung hinged casements with centrally located fixed lights
Right: Side hung hinged casements with centrally located fixed lights

Sliding sash windows



Traditionally formed timber sliding sash windows



Maintenance of windows

Section 1

Section 1: Maintenance of Windows

Timber Windows

Timber sash and casement windows are of a simple design and construction method, making them relatively easy to maintain.

Neglecting to carry out regular maintenance to timber frame windows, as part of a maintenance program, is an all too common problem which eventually leads to the need for repair and in some cases wholesale replacement.

Therefore, a regular maintenance programme of cleaning and painting to protect against weathering, particularly in exposed areas, will extend the life of a window, besides being more cost effective than installing new windows.

Typical problems which may be encountered when assessing timber windows, that would be considered as general maintenance may include:

- Cracked and flaking paintwork: the outside of the windows should be repainted at regular intervals.
- Sticking windows: usually the result of a build-up of paint which needs to be removed.
- Failed putty and broken glass panes: these are relatively easy to replace.
- Broken cords: re-cord - the cords and sash weights are available at most hardware outlets.
- Timber decay, particularly to the bottom rail: and more significant repairs should be carried out by any competent joiner / carpenter familiar with traditional techniques.

Metal Windows

Prior to undertaking an assessment on the condition of a metal window it is important to understand the type of metal used for the window (iron, steel, bronze or aluminium) as this will determine the maintenance approach taken.

However, typical problems which may be encountered when assessing metal windows, that would be considered as general maintenance may include;

- Cracked or loose pointing between the frame and the wall opening, encourages water ingress and gradual erosion - remove any cracked or loose pointing and repoint in a like for like (identical) material.
- Corrosion of the metal frames (signs of rusting) - rub down and treat with appropriate primer before repainting.
- Excessive build-up of paint, failed hinges or fittings - remove excessive paint and replace failed or missing ironmongery.



Fig. 3
Metal window
demonstrating lack of maintenance

The advice offered within this document on the **maintenance** of timber and metal windows, is not exclusive, merely a starting point. There is a good selection of technical advice available from reputable sources, some of which can be found at:

- ❖ Pickles D, McCraig I and Wood C 2014. *Traditional Windows: their care, repair and upgrading*, Historic England (2014)
- ❖ Hunt R & Suhr M (2008) *Old House Handbook, A PRACTICAL GUILDE TO CARE AND REPAIR*, In association with The Society for the Protection of Ancient Buildings.





Repair of windows

Section 2

Section 2: Repair of Windows

Timber Windows

The most common cause of decay in timber windows is through moisture penetration, which can easily be managed by regular inspection, painting and piecemeal repairs as part of a programmed maintenance routine.

However, where decay is detected in the frame, it is imperative to identify and address the cause, prior to carrying out repairs. Where feasible the window should be repaired in situ, by removing the affected area and splicing in new timber sections, as this allows for the retention of as much fabric as possible, conserving the visual character and appearance of the building and the contribution it makes to the immediate and wider area.

When approaching the repair of timber windows, it is important to use timber that matches that of the original; otherwise newly introduced poor quality timber will always be more vulnerable to decay, resulting in a short-term solution. Appointing a skilled craftsman would ensure the repair works are carried out to a standard acceptable to the long term repair of the window, in accordance with good conservation practice.

Example of traditional joinery repair



Decayed timber frame and cill



Frame and cill routed to expose sound timber



New timber spliced into the frame and made good ready for decoration



A traditional repair in situ

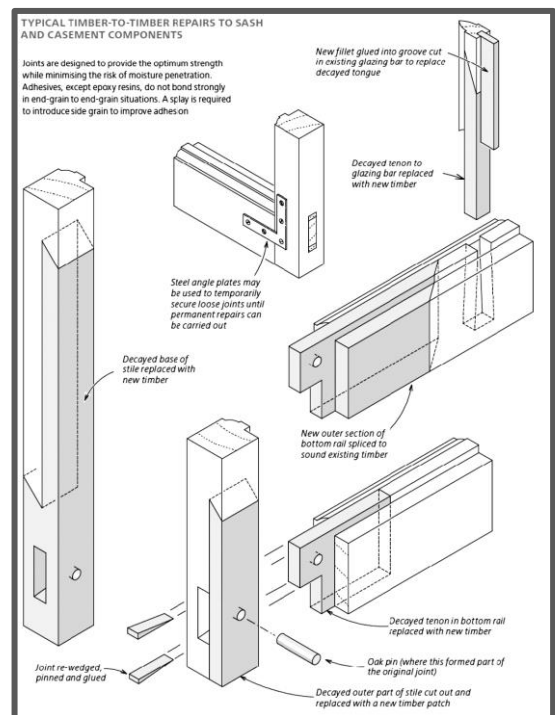

Left: Fig 4 a traditional timber repair

Right: Fig 5 technical example of traditional joiner repair

Metal Windows

The repair of metal windows will always depend on the type of metal used as part of the initial method of production. The metal and production process will in turn, determine the level of galvanization used, if any.

It's important to remember, with metal windows, the visual appearance of rust is more often than not, looks more detrimental to the structural integrity of the window than it actually is. In this respect, there are specialists in the repair of metal and seeking their advice is essential prior to considering repair and or wholesale replacement.

Fig 6 Example of metal repair



The advice offered within this document on the **repair** of timber and metal windows, is not exclusive, merely a starting point. There is a good selection of technical advice available from reputable sources, some of which can be found at:

- ❖ Pickles D, McCraig I and Wood C 2014. *Traditional Windows: their care, repair and upgrading*, Historic England (2014)
- ❖ Hunt R & Suhr M (2008) *Old House Handbook, A PRACTICAL GUIDE TO CARE AND REPAIR*, In association with The Society for the Protection of Ancient Buildings





Section 3

Replacement windows

Section 3: Replacement Windows

Replacement of traditional windows should only be undertaken if the windows are beyond economic repair.

When replacing a window that makes a historic and or architectural contribution to the significance of the building and or area, all the key components (detailing) of the existing window should be replicated in an accurate way, to ensure the integrity of the building's original intent is retained.

Fig 7 Components (detail) of a typical sash window with exposed box

Detailing

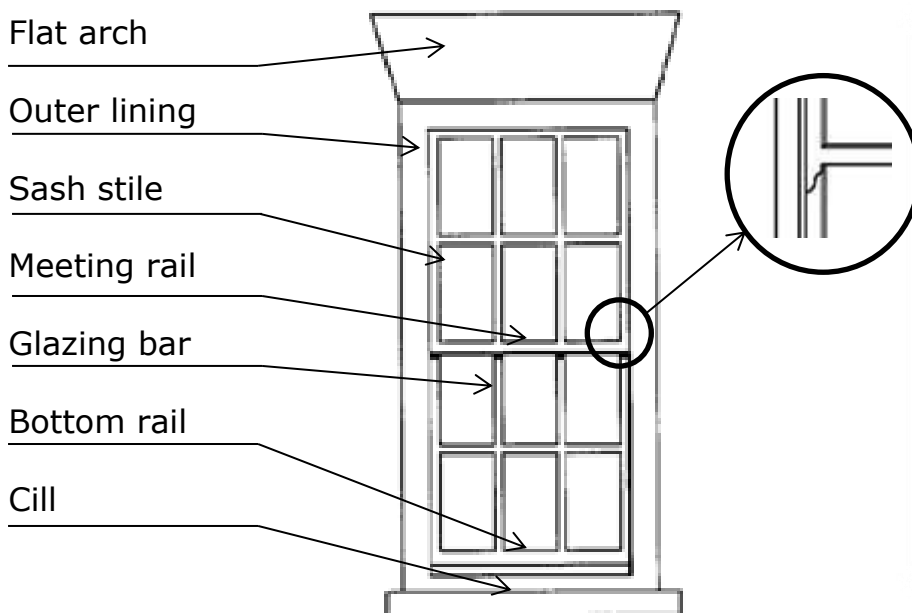

Note: the above window, due to its age would not have had window horns. However these are a key component of later timber sash windows, located below the meeting rail, as an extension to the sash stile and these should be replicated, if appropriate, in any replacement proposal.

Where old glass remains, this should be removed carefully and re-used, as should ironmongery be overhauled and reused.

In the case of sliding sash windows, substitutes for pulleys and weights, such as counterbalancing springs, inevitably have an adverse impact on the overall appearance of the window, as the spring loaded mechanism results in a smaller rebate, contrary to the larger, mostly decoratively moulded rebate found in a traditional constructed sash window.

Material

One of the biggest threats to the character and appearance of a conservation area, area of high townscape value, listed building or building of local interest, is the use of uPVC as a replacement for timber sash or casement windows. Whilst the uPVC plastic window industry has made significant progress in recent years to improve the external appearance of plastic windows, they remain instantly recognizable as their proportion and detailing cannot match that of historic joinery.

The integrity of a uPVC window is based on factory made components, designed for rigidity, thermal performance and ease of production. Their design and detailing make them look different to traditional windows, as manufacturers are unable, due to limited strength of the material and additional weight of the double glazed units, to replicate sections or 'glazing bars', and as a result these are more often than not introduced as a token to the traditional glazing bar as a thin strip of plastic inserted within the sandwich of the glass or applied on the outer surface.

In addition to the inappropriate detailing and size of the sash stile, meeting and bottom rails and glazing bars, the misguided introduction of different designs to that of the original, disrupts the window hierarchy and in turn the integrity of the building and its character.

Fig 8: Example of traditional timber (left) vs uPVC windows (right)



Note: The uPVC windows to the right have not replicated the horns, characteristic features of a traditional sash window for the age of the property. Another key feature that detracts from the inherent character of the building is the opening mechanism of a uPVC which is more reflective of a top hung casement in comparison to the aesthetic merit of a sliding sash.

NOTE: It is important to remember when a window is replaced, the **new** window would need to comply with Building Regulations. In the case of listed buildings any replacement should be discussed with the Specialist Advisor (Conservation) prior to carrying out any work.

Examples of the visual harm to the character and appearance of the built environment, through the introduction of plastic uPVC windows.



Left: Plastic (uPVC) replacement windows. Demonstrating the associated harm on the visual integrity of the building, through the loss of the key characteristics found in traditional construction techniques. Additionally due to the manufacturing process, to achieve ease of production, the opening mechanism is achieved through a top opening casement, contrary to the integrity of sliding sash windows and potentially disruptive to the interpretation of the aesthetic merits associated with the buildings original design intent and its contribution to character and appearance of the immediate and wider area.

Right: Sliding sash window, typical for the age of the property. Demonstrating characteristic traditional construction techniques through the use of material (timber), presence of horns, narrow sash stiles and vertical glazing bars which provide an insight into the social hierarchy of the room through the use of small panes of glass on account of cost





Thermal Upgrading

Section 4

Section 4: Thermal Upgrading

Replacing single glazed windows to achieve comfort and reduce heating costs, is one of the biggest threats to the historic and architectural character and appearance of the built environment.

How can thermal properties of single glazed windows be upgraded

Draught proofing

Draught-proofing is a cost effective solution to reducing draughts and improving thermal efficiency and noise insulation of traditional or existing windows, whilst retaining the character and appearance of the existing windows.

Introducing a draught or weather strip to existing windows will not only provide insulation, but as an inconspicuous introduction, will go towards retaining the integrity of the window and its contribution to the architectural character and appearance of the building, its immediate and wider setting.

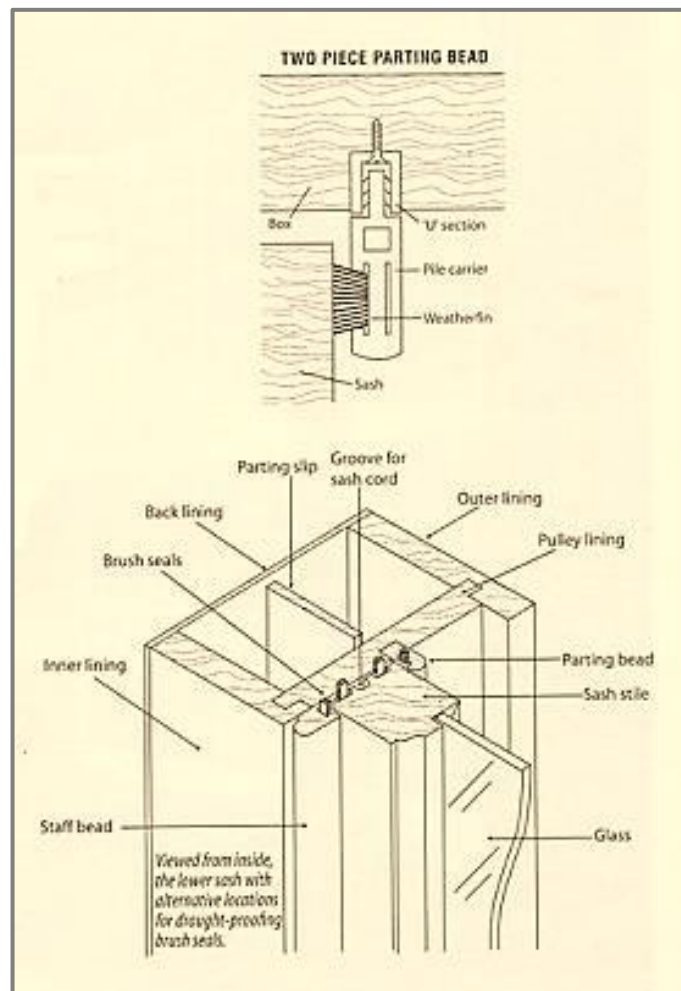

Fig 9 - Examples of joinery repair

Secondary glazing

Internally fitted secondary glazing units can be an effective measure to reduce noise and heat loss. However this approach, if not carefully designed, can be harmful to the visual appearance of the window.

If purposely designed to respect the existing window, secondary glazed units can be relatively unobtrusive, provided they do not damage existing features such as shutters or window surrounds.

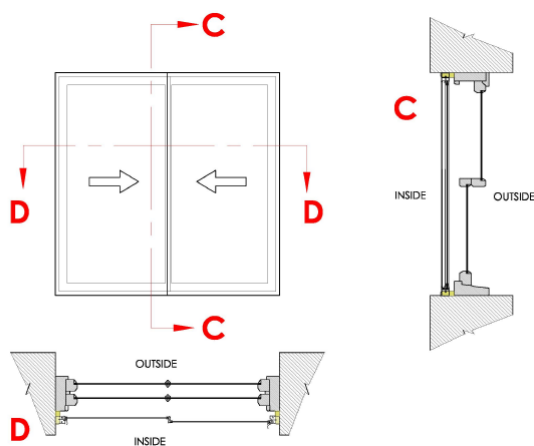

Fig 10 – Example of one of the dormer window secondary glazing unit, agreed by the Local Planning Authority and residents, to be used as part of the thermal upgrading of the residential apartments at All Saints, Meads. A former convalescent hospital, built in 18967-1869 in the gothic revival style now classified as a Grade II* heritage asset.

Simple measures such as heavy curtains, blinds or existing shutters where appropriate can improve the thermal properties of windows with little or no intervention of significance.

Research into the behaviour of traditional windows

Historic England and Historic Scotland commissioned research, primarily focusing on thermal behaviour of traditional windows.

Results of the research and further information in relation to thermal upgrading of traditional windows can be found in Historic England (2015) *Traditional Windows Their Care, Repair and Upgrading*, an extremely informative document that can be downloaded for free from the Historic England website





Planning Legislation

Section 5

Section 5: Planning Legislation

It is important to note that Eastbourne Borough Council **does not** have a dedicated planning policy which relates specifically to the renewal or replacement of windows.

However replacement windows which require approval by the Local Planning Authority, through the development management process (planning), would be considered in accordance with;

- Section 12 of The National Planning Policy Framework [NPPF] and associated Guidance,
- Policy D10 of The Core Strategy Local Plan 2013; and
- The Eastbourne Borough Plan 2001-2011 (Adopted September 2003), saved policies 2007
- The Eastbourne Townscape Guide, 2004 (Supplementary Planning Guidance)
- Significance see **Section 6**

In addition the design of any replacement window will be considered against its design in accordance with;

- Policy D10a of The Core Strategy Local Plan 2013



Policy D10a of the Core Strategy Local Plan 2013, which seeks to achieve a high quality environment where new development makes a positive contribution to the appearance of our townscape and urban heritage.

Part: D10A: Design

In order to achieve a high quality environment new development makes a positive contribution to the appearance of our townscape and urban heritage. Design and layout should take account of context, i.e. neighbouring buildings as well as the surrounding area. New development can be modern or based on historic forms but must respect, preserve or enhance local character. It is vital that design goes beyond the focus of the individual development and also takes account of sense of place, safety and security. Eastbourne's built environment should be of an exemplary standard. It will be protected and enhanced and development will be expected to:

1. seek exemplary standards of design and architecture that respects Eastbourne's unique characteristics;
2. apply national and regional policies in respect of design, landscape townscape and historic heritage;
3. ensure that the layout and design of development contributes to local distinctiveness and sense of place, is appropriate and sympathetic to its setting in terms of scale, height, massing and density, and its relationship to adjoining buildings and landscape features;
4. ensure that new development makes a positive contribution to the overall appearance of the area including the use of good quality materials, reusing existing materials where appropriate, and seeking to achieve a high standard of finish;
5. promote local understanding of good innovative and imaginative design; and
6. ensure new development is accessible to all and designed to minimise crime and anti-social behaviour without diminishing the high quality of the overall appearance.

It is important to remember that **BOTH** the local planning authority and applicant have a duty under the NPPF to understand the level of significance a heritage asset yields.

Applicants

National Planning Policy Framework 128:

In determining applications, local planning authorities should require an applicant to describe the significance of any heritage assets affected, including any contribution made by their setting. The level of detail should be proportionate to the assets' importance and no more than is sufficient to understand the potential impact of the proposal on their significance. As a minimum the relevant historic environment record should have been consulted and the heritage assets assessed using appropriate expertise where necessary. Where a site on which development is proposed includes or has the potential to include heritage assets with archaeological interest, local planning authorities should require developers to submit an appropriate desk-based assessment and, where necessary, a field evaluation.

Local Planning Authority

National Planning Policy Framework 129:

Local planning authorities should identify and assess the particular significance of any heritage asset that may be affected by a proposal (including by development affecting the setting of a heritage asset) taking account of the available evidence and any necessary expertise. They should take this assessment into account when considering the impact of a proposal on a heritage asset, to avoid or minimise conflict between the heritage asset's conservation and any aspect of the proposal.

Listed Buildings

Buildings are listed for their special architectural or historic character and interest. All listed buildings are protected under the Planning (Listed Buildings and Conservation Areas) Act 1990 and the listing covers both the interior and the exterior of the building in conjunction with any structure within its garden or plot (curtilage) dating from before 1 July 1948. Listed building consent is required for any work to the building which affects its character or special interest, and it is a criminal offence to alter a listed building without listed building consent.

An application for listed building consent is required when:

- the windows are to be replaced with a new style of window,
- there is a change to the materials used for the frames,
- there is a change in the type of glazing e.g. single glazing to double glazing,
- it is proposed to re-glaze, involving the loss of original or old glass.

National Policies

National Planning Policy Framework 132:

When considering the impact of a proposed development on the significance of a designated heritage asset, great weight should be given to the asset's conservation. The more important the asset, the greater the weight should be. Significance can be harmed or lost through alteration or destruction of the heritage asset or development within its setting. As heritage assets are irreplaceable, any harm or loss should require clear and convincing justification. Substantial harm to or loss of a grade II listed building, park or garden should be exceptional. Substantial harm to or loss of designated heritage assets of the highest significance, notably scheduled monuments, protected wreck sites, battlefields, grade I and II* listed buildings, grade I and II* registered parks and gardens, and World Heritage Sites, should be wholly exceptional.

National Planning Policy Framework 133:

Where a proposed development will lead to substantial harm to or total loss of significance of a designated heritage asset, local planning authorities should refuse consent, unless it can be demonstrated that the substantial harm or loss is necessary to achieve substantial public benefits that outweigh that harm or loss, or all of the following apply:

- the nature of the heritage asset prevents all reasonable uses of the site; and
- no viable use of the heritage asset itself can be found in the medium term through appropriate marketing that will enable its conservation;
- conservation by grant-funding or some form of charitable or public ownership is demonstrably not possible; and
- the harm or loss is outweighed by the benefit of bringing the site back into use.

National Planning Policy Framework 134:

Where a development proposal will lead to less than substantial harm to the significance of a designated heritage asset, this harm should be weighed against the public benefits of the proposal, including securing its optimum viable use.

Local Policies

The Core Strategy Local Plan 2013

Part: D10 Historic Environment:

All significant heritage assets will be protected and enhanced, where practicable:

There is a presumption in favour of protection of all heritage assets from inappropriate change, including both designated (Listed Buildings, Conservation Areas) and non-designated assets (Buildings of Local

Interest, Areas of High Townscape Value).

- Listed buildings will be protected from demolition, and from proposed additions and alterations that would adversely affect their character, appearance and/or fabric. Development should not adversely affect the setting of listed buildings.

The Eastbourne Borough Plan 2001-2011 (Adopted September 2003), Saved Policies 2007. Chapter 5: Urban Heritage and Townscape

Policy UHT17: Protection of Listed Buildings and their Settings

Planning permission for alterations or extensions to a listed building will be granted only where the works would preserve the inherent character of the listed building and its features of special architectural or historic interest.

Planning permission will be granted for works affecting the setting of a listed building only where the development would not harm the character or appearance of the setting of the building.

The Eastbourne Townscape Guide, 2004 (Supplementary Planning Guidance)

Guideline WD1:

On listed buildings the Council will normally expect the retention of the original windows and doors or if missing, their re-introduction in the appropriate design and materials for the age of the building.

Conservation Areas

In conservation areas, planning permission is not normally required for the replacement of windows if the property is a single house (i.e. not flats or commercial property) however permission is required if your property is listed or in **The Park Close Conservation Area**, where the Council has issued an Article 4 Direction.

National Policies

National Planning Policy Framework 137:

Local planning authorities should look for opportunities for new development within Conservation Areas and World Heritage Sites and within the setting of heritage assets to enhance or better reveal their significance. Proposals that preserve those elements of the setting that make a positive contribution to or better reveal the significance of the asset should be treated favourably.

Local Policies

The Core Strategy Local Plan 2013

Part: D10 Historic Environment:

All significant heritage assets will be protected and enhanced, where practicable:

There is a presumption in favour of protection of all heritage assets from inappropriate change, including both designated (Listed Buildings, Conservation Areas) and non-designated assets (Buildings of Local Interest, Areas of High Townscape Value).

Development within Conservation Areas will be permitted if:

1. it preserves or enhances the character, setting and appearance of the area;
2. it does not involve the loss of important features which contribute to the character of the building itself or wider area;

- 
3. its form, bulk, scale, height, massing, materials and function of the development are appropriate to the development site and surrounding buildings, spaces and views;
 4. it does not involve all or the partial demolition of a building or feature which positively contributes to the character of the area, unless it can be demonstrated to be wholly beyond repair, incapable of beneficial use or is inappropriate to the character of the area.

The Eastbourne Borough Plan 2001-2011 (Adopted September 2003), Saved Policies 2007. Chapter 5: Urban Heritage and Townscape

Policy UHT15: Protection of Conservation Areas

Planning applications in a conservation area, or affecting the setting of a conservation area, will be required to preserve or enhance the character or appearance of the area.

The Eastbourne Townscape Guide, 2004 (Supplementary Planning Guidance)

Guideline WD2:

In conservation areas, the Council will normally:-

- a) expect historic buildings to retain the original design and material of their windows and doors;
- b) allow the use of alternative materials to an appropriate design on hidden elevations and new buildings.

Homeowners living in conservation areas who would not require planning permission for replacement of their windows are still encouraged to follow the advice given in this guidance note in terms of the maintenance and repair of their windows.

Local Heritage Assets (Buildings of Local Interest & Areas of High Townscape Value)

As well as the statutory listed buildings, the Council believes there are other buildings of local interest and areas of high townscape value that contribute to the townscape of Eastbourne. These buildings of local interest do not have the statutory protection of listed buildings but nevertheless they should be retained and ideally enhanced. Many of them stand in conservation areas so they cannot be demolished without consent. However many lie outside this protection and the Council will encourage owners to recognise the important contribution their building makes to the street scene.

National Policies

National Planning Policy Framework 135:

The effect of an application on the significance of a non- designated (building of local interest) heritage asset should be taken into account in determining the application. In weighing applications that affect directly or indirectly non designated heritage assets, a balanced judgement will be required having regard to the scale of any harm or loss and the significance of the heritage asset.

Local Policies

The Core Strategy Local Plan 2013

Part: D10 Historic Environment:

All significant heritage assets will be protected and enhanced, where practicable:

There is a presumption in favour of protection of all heritage assets from inappropriate change, including both designated (Listed Buildings, Conservation Areas) and non-designated assets (Buildings of Local Interest, Areas of High Townscape Value).

- Areas of High Townscape Value and Buildings of Local Interest will be conserved and enhanced through the application of the guidelines contained in the approved Eastbourne Townscape Guide and the use of Article 4 Directions.

The Eastbourne Borough Plan 2001-2011 (Adopted September 2003), Saved Policies 2007. Chapter 5: Urban Heritage and Townscape

Policy UHT18: Buildings of Local Interest

Proposals which would adversely affect the character or appearance of buildings of local interest will not be permitted. Should planning permission be granted for a major alteration, the consent will be subject to a condition to provide an opportunity for the building to be inspected and recorded.

Policy UHT16: Protection of Areas of High Townscape Value

Proposals within Areas of High Townscape Value will be required to generally preserve the character and appearance of the area. Development shall:

- a) use materials which respect and complement the predominant traditional materials of the location;
- b) not allow the loss of traditional materials and features;
- c) retain amenity spaces where they form part of the established character of the area; and
- d) retain, wherever possible, the existing trees and other important landscape features. In exceptional cases where any such loss is allowed, compensatory provision will be required in terms of quality and quantity.

The Eastbourne Townscape Guide, 2004 (Supplementary Planning Guidance)

Guideline WD3: In areas of high townscape value and buildings of local interest, the Council will normally:-

- a) expect the retention of the original doors and windows where these are in the majority on visible elevations of the individual building or the terrace if the premises forms part of a terrace;
- b) allow in cases other than a) above and on hidden elevations, or those not generally seen from public areas, the use of alternative materials for windows and doors in a matching style to the originals.

Building Regulations

Replacement windows must be upgraded to current Building Regulations thermal standards as part of the government's commitment to reducing overall CO2 emissions in buildings. However, Building Regulations Guidance documents recognize the importance of maintaining the special character of buildings that are either listed or in conservation areas, and advise close consultation between conservation officers and building control officers. It is often possible to provide alternative energy conservation measures within such buildings that do not have such a negative impact on the character of the building. If a building is listed, remember that listed building consent is required for any work which affects the character and special interest of the building.

The building control service for Eastbourne formed a partnership with Wealden District Council in 2011, to provide a shared service throughout both Authorities, known as East Sussex Building Control Partnership, based at the Council Offices in Hailsham.

Contact details

Telephone: 01892 602005; **Email:** Building.control@wealden.gov.uk

Address:

Planning and Building Control, Wealden District Council, Council Offices,
Vicarage Lane, Hailsham, BN27 2AX

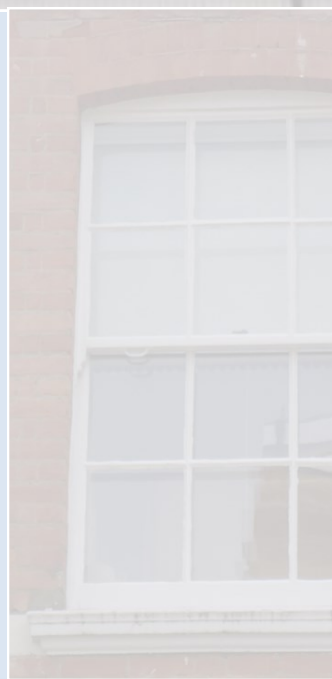

Section 6

Significance

Section 6: Significance

Overview

Heritage assets (listed buildings, conservation areas, buildings of local interest and areas of high townscape value) will inevitably be affected by physical change. Therefore identifying their heritage value through an assessment of their significance is necessary to understand the potential impact (positive or negative) any proposed changes may have on their interpretation for this and future generations.

Therefore surviving historic windows associated with all buildings that make a positive contribution to conservation areas, are irreplaceable and should be conserved through repair as much as possible.

In assessing the significance of a traditional window as a whole, its constituent parts should be considered against its heritage values, using the framework defined by *Historic England's Conservation Principles (2008)*.

The heritage value against which significance is measured has the following headings;

- **Evidential Value**
- **Historic Value**
- **Architectural Value and**
- **Communal Value**

The sum of these interrelated values equates to the overall significance of the windows and as such the contribution it makes to the historic, architectural character and appearance of the building and surrounding area.

Heritage Values

The following table demonstrates how the identified heritage values are interpreted through a window assessment.

<i>Heritage Value</i>	<i>Significance</i>
Evidential value	<p>Evidential value reflects the potential of a building or its fabric to yield information about the past, rarity adds to evidential value.</p> <p>Window: where the fabric of a window is 'old' this would yield high evidential value, in addition; if early 19th century sash windows were in an 18th century dwelling this would hold considerable evidential value, as part of the building evolution.</p>
Historic value	<p>In varying degrees, most historic windows will be of historic value demonstrating; materials, technology, craftsmanship and architectural taste of the period from which they date.</p>
Aesthetic value	<p>As the eyes of the building, windows form an integral part of a buildings visual character and contribute to its design and interest.</p>
Communal value	<p>Communal value may be more relevant in public buildings or places of worship than a domestic situation.</p>

Fig 11: An example of heritage assets in context of the evaluation of the significance of a circa. 1804 windows

Evidential Value

- Age : rarity
- Depth of reveal
- Original to the building or part of a later phase of development but high in evidential value in its own right.
- Thickness and profile of the glazing bar
- Age of the glass



Aesthetic Value

- Integral part of the buildings original design intent
- Reflectiveness of the glass
- Existence of horns
- Window hierarchy within the built form
- Materials - type
- Thickness and profile of the glazing bar
- Proportion

Historic Value

- Materials - type
- Technology – form of construction
- Craftsmanship – quality, glass
- Architectural taste of the period

Communal Value

- Communal value may be more relevant in public buildings or places of worship than a domestic situation

The identified values are interlinked, the sum of which identifies the value of the windows significance in context of the building and surrounding area.

The heritage value of a traditional window and the contribution it makes to the building as a whole is invaluable when deciding a way forward when in need of repair or replacement.



A brief history

Appendix 1

Appendix 1

A brief history of windows

A brief history on the historic development of windows, has been included, as it forms the platform from which the understanding of the historic value attached to windows contributes to the overall significance of the heritage asset (listed building, conservation area, building of local interest and area of high townscape value), including its relationship with the evolution of the immediate and wider area.

In simple terms the vast majority of windows comprise of two opening types; hinged casements and sliding sashes (vertical and horizontal). Those that don't open are known as fixed lights. All types were constructed in either metal (in the form of wrought iron, cast iron, steel or aluminium) or timber.

Regardless of their use of material or mechanism for opening, aesthetically the proportions, detailing and glazing pattern of traditional windows are imperative to the integrity of the building's significance.



Fig. 12

Traditional timber sash windows (left) and top hung casements in conjunction with fixed lights below (right)

Meads Street, Meads
Date Unknown

Window Openings

Due to the rarity and expense of glass for domestic use in the medieval period, the vast majority of window openings were unglazed.

In timber framed buildings, windows formed part of the structural frame, as simple openings. Where windows were wider in form, these were sub-divided, with plain or moulded mullions, of two or more 'lights' (openings), while taller openings included horizontal transoms as a form of sub-division.

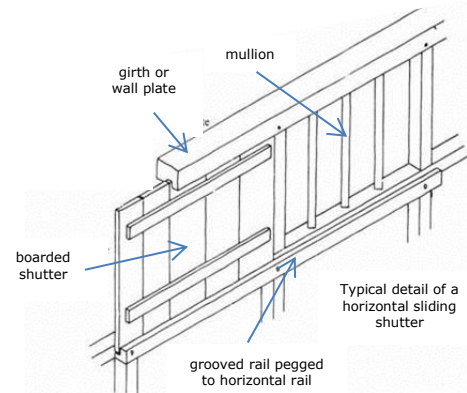

Means of security was achieved with the introduction of a wooden or iron bar, whilst privacy and the exclusion of draughts, achieved by the introduction of hinged or horizontal internal sliding shutters. In addition, these openings were often covered with an oiled cloth nailed to the structural frame, this however restricted natural light and views.

Until the 16th century glazing in window openings remained exclusively for the wealthy, following which hinged casement, leaded lights set in metal, became a recognizable domestic feature and subsequently grew into an important, architectural feature defining the status of the owner.

As the introduction of glazing within window openings became more affordable as a common domestic feature, the proportion associated with the early 17th century timber frame, allowed for the introduction of larger windows, externally fixed (pegged) to the structural frame. However by the end of the 17th century traditionally formed casement and sash windows, fixed within the window openings were becoming more 'fashionable' in response to the production of larger panes of glass and their affordability.

The positioning of the window within the opening (reveal) has changed significantly, where the whole of the window frame including the sash box was initially placed on the outer face of the wall, resulting in a wider timber surround. This approach soon changed as a result of The Great Fire of London, where the 1709 London Building Act required, the box sashes to be set back 'four inches' from the face of the building, to assist with the reduction of the spread of fire.

Subsequently, The London Building Act of 1774, required the sash boxes (housing the weights) to be positioned behind the masonry, a stipulation that

resulted, in the glazed area of the window, being more prominent within the elevation.

An improvement in the production of glass and the introduction of glazing bars; transformed the appearance of the building and as such interpretation of our cities, towns and villages



Pre 1709



Post 1709



Post 1774



Post 1840

Fig. 13
Evolution of the window reveal in reaction to
The London Building Act of 1709 & 1774

Glazing

The production of glass has been influential to the social and aesthetic evolution of the built form, contributing to the appearance of the built environment.

Whilst glass has been produced in sheets and used since the 12th century (Broad Glass), it was only from the late 16th century that glass became significant in the appearance of domestic windows, in the form of leaded lights (broad glass was cut into small sections, usually diamond shaped fixed together with lead strips known as cames).

By the mid-18th century, the introduction of excise duty on glass by weight, favoured the crown-glass process, as this allowed for thinner panes of glass to be produced, albeit of a limited size, however its weight allowed for larger sashes.

By the 17th and 18th Centuries, crown glass-making was the most widely used technique for glass production, when the supply of glass became widespread.



A globe is formed at the end of a blowpipe



The globe is opened out at one end to form a bowl

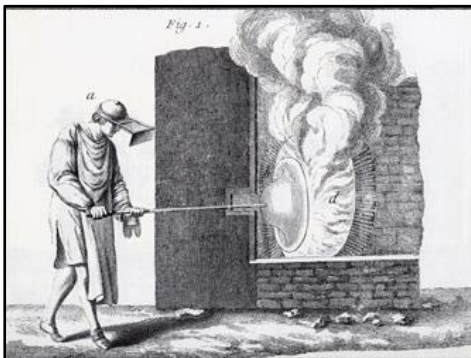

The bowl is reheated and spun quickly, centrifugal force has caused the bowl to form a flat disc

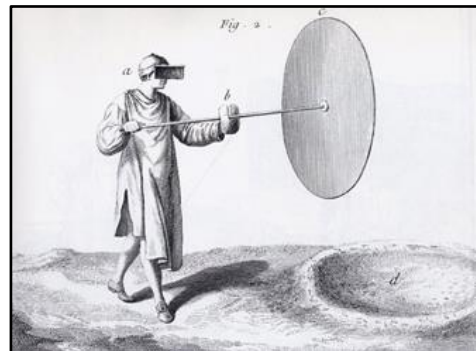

The flat disc is placed flat on a bed of sand and the 'rod' broken off leaving the bulls eye

Fig. 14 The production of crown glass in the late 18th century

After the removal of excise duties in the mid-19th century and the improved production of glass, cylinder glass provided the opportunity to produce larger panes although of poorer appearance than plate or crown glass, allowed for better views out of the building.

Fig. 15 The production of cylinder glass

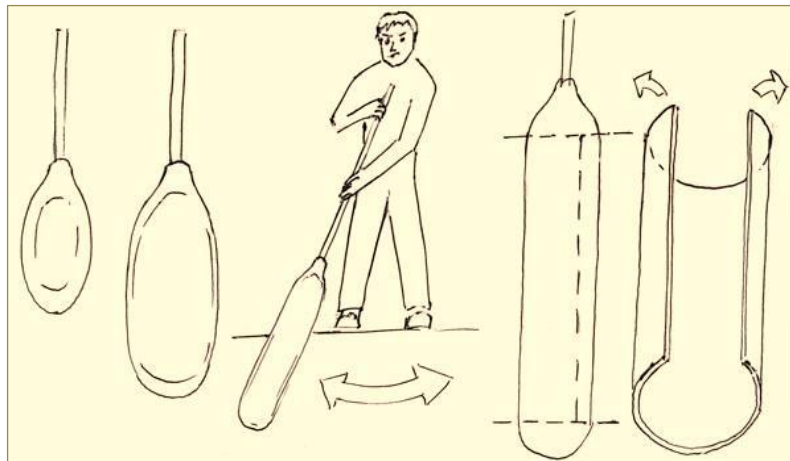

Produced by 'swinging a freshly blown glass bubble so that it elongated by centrifugal force, both ends of the cylinder were cut off to form a tube which was then split down one side from end to end and opened out to form a flat, square sheet.'

Whilst glass-making technology made swift progress in the 19th and early 20th centuries, it was only in 1959, when Pilkington invented the 'float glass process' 'by which a strip of molten glass was drawn from a furnace over a bed of molten tin' that a perfect surface of glass was achieved, supplied cheaply in a wide range of sizes and thicknesses.

Glazing bars

Initially the production of glass defined the location, scale, use of material and design of the glazing bar. However as glass became more available and affordable glazing bar patterns and profiles started to define the social status of the windows in the context of the building and its setting.

Given the size and weight of glass, early glazing bars were numerous and thick, the internal pattern of the bar was moulded, to reduce glare and deflect light, whilst the outside was rebated to take the glass pane, held in place with putty, a technique which continues to be used today.

As the production of glass evolved, so did the glazing bar, which gradually reduced in size reaching a point in the late 18th century and early 19th century to a width of 13mm, the type of material used to produce them, was critical to their strength, to accommodate the increase in glass panes.

Historic glazing bar profiles					
Profile					
Date	1689-94	1705	c1750	1721	1775-86
Width	40mm	30mm	22mm	19mm	15mm
Depth	42mm	33mm	44mm	32mm	40mm

Fig 15. Historic glazing bar profiles

As the production of glass improved to larger and cheaper panes, and glazing bars reduced in size and number, so did the appearance of the window. Windows started to define style as opposed to necessity through the limitations of glass production or costs.

In the early 19th century, with the introduction of large sheets of cheaper glass, it became fashionable to reduce the number of glazing bars in the lower sash, to allow for views. However in the 1820's and 30's the top sashes remained multi-paned resulting in the introduction of window 'horns' to

accommodate the additional weight of the upper sash. And by the late 19th century with the support of elegantly styled horns, sash windows saw the introduction of large panes of sheet glass, to both the upper and lower sashes frames.

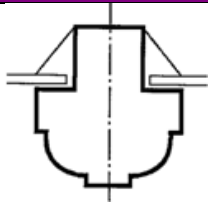
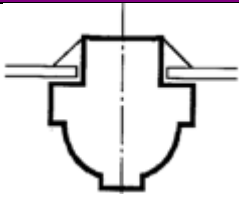
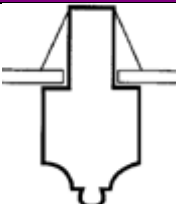
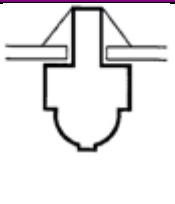
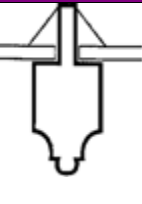
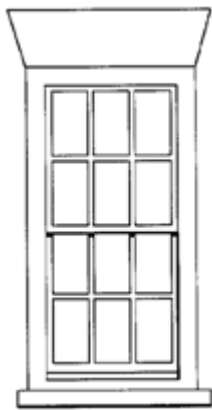

Fig. 16
Early 18th century sash windows. As the price of larger sheets of glass fell, the 'six-over-six' window became common

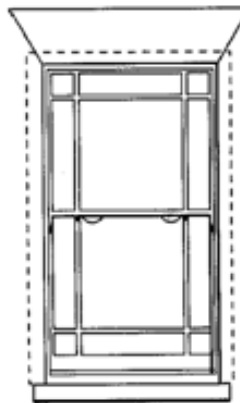

Fig. 17
A Regency window with 'margin lights'. Excise duty on glass generally favoured the use of small light panes of crown glass, so the introduction of small margin lights around a large central pane, which was fashionable in the 1820s, was an elegant but significantly more expensive departure from the usual six-over-six sash

However by the end of the 19th century small panes returned to the upper sashes, to some degree in reaction to the Queen Anne revival, heavily influenced by the Arts & Crafts Movement. This led to multi-pane upper sash frames with thick glazing bars and larger panes of glazing to the bottom sash frame, the positioning of the window frame was also influenced by fashion, in that the window was once again placed on the façade of the building with the boxes showing, these were often mixed with casement windows within the same façade. The interpretation of the window as part of the building is therefore a conscious design feature important to the character of the building.



Modern glazing bar profiles		
Profile		
Description	Typical Victorian 'Lamb's tongue'	Typical modern double-glazing (reproduction)
Width	15mm	45mm
Depth	35mm	64mm

Fig. 18 Modern glazing bar details

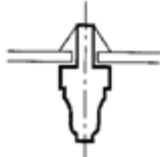
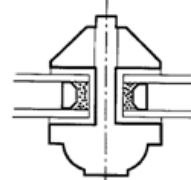

The development of the appearance of the casement window, followed that of the sash windows, with small panes being replaced with larger panes and smaller glazing bars. Besides which the design of the timber casement, remained unchanged throughout the 18th and 19th centuries.

Opening lights were normally hinged at the side, separation between the lights within the same window was provided by a timber mullion. Where lights were fixed (non-opening) these each had their own casements and rarely directly glazed into the frame. Original casements never overlapped, finishing flush with the frame resulting in a more refined appearance, unlike modern 'stormproof' windows, which are more bulky in appearance.

Whilst leaded lights and metal casements were used throughout the 17th and 18th centuries these were predominantly for church buildings, remaining rare in domestic architecture, until the Georgian and Gothic revival which saw them become fashionable again. Metal casements and leaded lights marked the Tudor and Jacobean revival in suburban housing in the late 19th and early 20th century, whilst small paned timber casements together with sash windows marked the Queen Anne revival from the 1860's, with the timber casement continuing its popularity until present day.

After the First World War, the use of metal for casements was transformed by F W Crittall, the 'hot rolled steel sections' form the basis of the classic 1920's and 30's metal window, we identify with today as a 'crittall'. The metal window was adopted by the modern movement and their strength, cost effectiveness, fire-resistance and slim profile, made them very competitive in buildings that were designed for fresh air and light.

The evolution of steel windows saw the introduction of galvanized frames in the mid-20th century, which later saw the introduction of aluminium, also used for curtain walling

Window Features

Window features are integral to providing clues to the history of the building and the social status of past occupants and as such, an important part of the window when assessing the contribution that windows make to the significance of buildings and their setting.

The window features briefly discussed as part of this document are not exclusive, but include shutters and ironmongery as common and recognisable window accessories or features.

Shutters

Evidence of the use of shutters for draft prevention, privacy and security can be found as early as in medieval timber frame buildings. Subsequent to which their use, albeit in conjunction with glazing, continued and is a key feature of Georgian windows.

In the 17th century their form of construction became more sophisticated, the culmination of which made a contribution to the aesthetic quality of the building and status of the owner.



Fig 19

Example of a Georgian internal bi-folding timber shutter

Ironmongery

Ironmongery in the form of H-shaped hinges can be found as supports for leaded casement windows in early timber frame buildings.

However the arrival of the sash window in the 17th century, encouraged the need for a range of ironmongery which later became diverse, in the form of pulleys, lead weights, shutter hinges, knobs and fasteners.

While brass or hardwood was widely used for Georgian and Victorian sash window pulleys, the improvement of casting techniques introduced cast-iron pulleys and sophisticated axle pulleys. That said, when considering dating

techniques based on material evidence, the 19th century brass continued to be used for hinges and fittings in less sophisticated buildings.

Towards the later part of the 19th century, a diverse selection of ironmongery was available for use in the revival period (Stuart and Georgian) and became popular with the Arts & Crafts Movement. However by the mid-20th century aluminum fittings became popular, although today ironmongery has revived itself through the interest in old homes

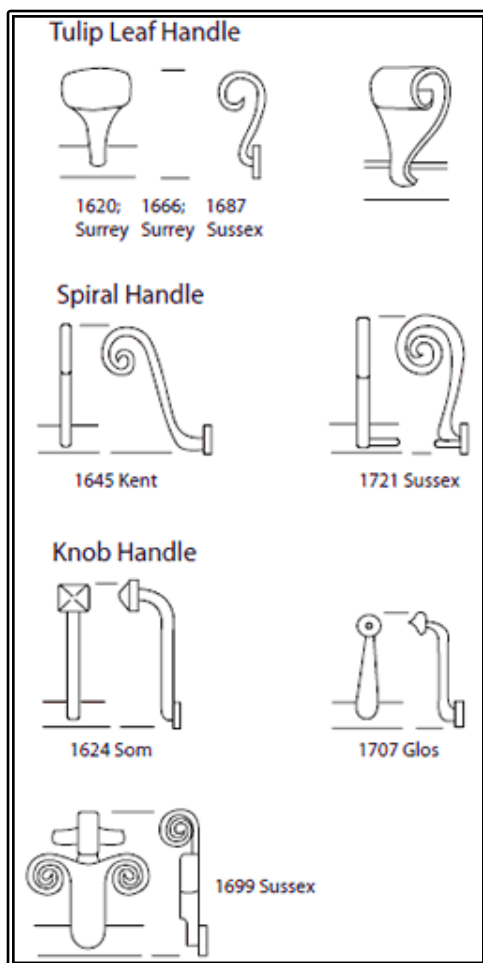

Fig 20
 Example of traditional handles

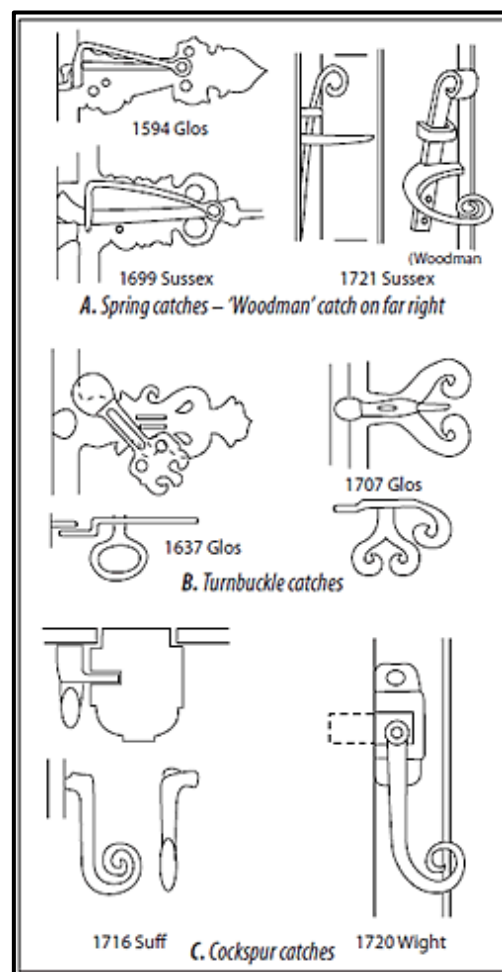

Fig 21
 Example of traditional cockspur catches



Appendix 2

Glossary

ASTRAGAL - A moulded wooden glazing bar.

BAY WINDOW - A projecting window beginning on the ground floor and sometimes embracing several storeys; usually square or canted.

BOW WINDOW - A curved bay window.

BOX, BOX FRAME - The outer (hollow) casing of a timber sash box - sash window, which houses the counterbalancing weights, enabling the sashes to move up and down with ease. Early examples were carved out of solid wood, but later made up from separate components. .

BULL'S-EYE GLASS - The central remnant of a crown glass disc; originally used only in the least important windows.

CANTED BAY - a bay window where the sides, instead of being square, are usually at an angle of 45° or 60° to the wall, but which can be as low as 15° (then referred to as a shallow bay).

CASEMENT WINDOW - A window with the sash, or light hinged at the side so as to open outwards or inwards. A top-hung casement has the hinges at the top and opens outwards.

CILL, SILL - The lowest horizontal member of a timber window; also the projecting stone member on which the window sits.

CROWN GLASS - Glass formed by the now obsolete method of spinning molten glass into a disc on the end of a blowpipe; the disc was cooled and then cut into rectangular panes.

CYLINDER GLASS - Sheet formed by blowing an elongated cylinder from molten glass, which is then cut along its length and laid flat, to cool, before being sub-divided into smaller sheets.

DOUBLE GLAZING - Glazing in which two layers of glass are separated by an air space for the purpose of increasing sound-insulation and reducing heat loss. See also sealed unit.

DOUBLE-HUNG - A sash window in which both sashes or sash window - lights are capable of moving up, or down, and are counterbalanced by weights concealed within a sash box.

EDGE SEAL - A plastic material used around the outer edges of a sealed unit, usually incorporating a desiccant to absorb moisture.

FENESTRATION - The arrangement of windows in a facade; also refers to the size and proportion of the windows, and sometimes to the subdivision within a window. .

FLOAT GLASS - Glass sheets made by floating molten glass on a surface of molten metal, thereby producing a smooth relatively flat surface which does not need polishing.

FRAME - See sash. .

GEORGIAN - A development of the style prevalent in the reign of Queen Anne, and covering the period 1714 (George I) to 1830 (death of George IV), a span of 115 years.

GLAZING BAR - The solid wooden framing piece made to receive panes of glass.

HORNS - A downward extension of the timber side members of the top sash of a 19th century window, initially rounded off, later elaborately shaped.

IRONMONGERY - Internal fittings, not always of iron, such as pulleys, catches, handles and finger pulls.

JAMB - The side of an opening in a wall, for a door or window; or that part of a frame which sits against the side of an opening.

LIGHT - A metal or timber frame with glass panes or quarries which may be fixed or open able.

LINTEL - A beam over an opening in a wall supporting masonry above.

MARGIN LIGHTS - Narrow panes of glass at the edges of a SASH.

MEETING RAILS - The top member of the bottom sash, and the bottom member of the top sash, together

MULLION - A fixed vertical post or other upright dividing a window into two or more lights.

ORIEL -A projecting window which, unlike a bay, is supported off the face of the building (often by brackets) not off the ground.

PANE - A sheet of glass cut to fit into a light or sash, held in position by astragals or glazing bars.

PARTING BEAD - A narrow vertical strip of wood at the centre of the pulley stile of a sash box, which keeps the top and bottom sashes apart, and allows them to slide past each other; removable for maintenance of the upper sash.

PLATE GLASS - Glass of better quality than sheet. POLISHED PLATE - Glass which has been cast flat, then ground and polished and therefore has two smooth faces.

PULLEY - The grooved wheel over which the sash cord passes.

uPVC - Poly vinyl chloride; a type of plastic used extensively for making new and replacement windows. .

QUEEN ANNE - Queen Anne's reign (1702-14) saw the development of the earlier forms and styles of building from the times of Charles 11 and William and Mary ('late Stuart'). The term was adopted (not entirely accurately) by the exponents of the 'Queen Anne Revival', to describe a combination of asymmetry, informal planning, and detailing taken from English and Flemish domestic buildings of the 17th and 18th centuries (known at the time as 'Free Classicism') .

REAMY - Used to describe glass with wavy imperfections. See also seed.

REBATE - A rectangular shaped recess cut into the edge of a piece of timber.

REGENCY - Strictly speaking, the period (1811-1820) during which the future George IV took over from his father the 'mad' George III and acted as Regent (i.e. reigning in the place of the King). Generally, in architecture, the term is taken to mean the period from the 1790s to about 1840. It is therefore synonymous with 'late Georgian', and embraces the reign of William IV and the first few years of Queen Victoria's reign. .

REPLACEMENT - The act of substituting a new thing for an old thing, frequently without due consideration.

REVEAL - The sides of a door or window opening which are at 90° to the face of the wall in which the opening sits.

SASH - A frame of timber containing glass panes or a single glass pane, originally from the French word chassis (meaning frame). Sometimes confusingly, in older documents, having the same meaning as casement.

SASH BAR - See glazing bar, astragal. **SASH BOX** - See box.

SASH CORD - A rope, cord, or line fixed to the side of a frame or sash, which passes over a pulley into the box frame and is attached at its other end to a sash weight, made of lead or cast iron.

SASH LINE - See sash cord.

SASH WEIGHT - A piece of lead or iron which counterbalances the sliding sash window, by means of sash cords and pulleys.

SASH WINDOW - A type of timber window in which two frames or sashes slide vertically over each other. Horizontally sliding sash windows also exist, (see Yorkshire lights).

SEALED UNIT - double glazing in which air is withdrawn from the space between two sheets of glass to form a vacuum, and the edges sealed.

SECONDARY GLAZING - A system of sliding or removable inner windows, usually of lightweight construction, intended to increase thermal and acoustic insulation.

SEED - Small air bubbles or other material imperfections found in old glass. See also reamy.

SEGMENTAL HEADED - As opposed to a flat or semi-circular arch or elliptical arch, a curved arch which is formed out of a small segment of a circle. A window in such an arch should normally follow the same curve, but in replacement work the window is often made with a flat head, and the remaining space filled solid.

SHEET GLASS - Ordinary window glass, not of such uniform thickness as float or plate glass.

SINGLE-HUNG - A sash window of which only one sash, usually the bottom one, slides vertically.

SLIDING SASH - A window which slides, usually vertically but sometimes horizontally, within an outer frame.

SOFFIT - The visible underside of a projecting surface, beam or lintel.



SPIRAL BALANCE - A spring-operated substitute for cords, pulleys, and weights in a double-hung sash window, introduced in the 1930's.

STAFF BEAD - A moulded timber member on the inside of a sash box, which keeps the bottom sash from falling out, and is removable for maintenance of the sashes.

STILE - A vertical side piece; that part of a sash box against which the sashes move up or down.

TRANSOM - A fixed horizontal bar of wood or stone across the opening of a window, dividing a window into two or more lights.

WEIGHT - See sash weight.

YORKSHIRE LIGHTS - Horizontally sliding window frames, sashes, or lights; usually in a pair, one fixed and one moving, but sometimes in threes (the central panel normally being fixed).



Reference

Reference

English Heritage, 2008. *Conservation Principles, Policies and Guidance for the Sustainable Management of the Historic Environment*. London: English Heritage

English Heritage 2009. *Research into the Thermal Performance of Traditional Windows: Timber Sash Windows*

Hunt R & Suhr M (2008) *Old House Handbook, A PRACTICAL GUILDE TO CARE AND REPAIR*, In association with The Society for the Protection of Ancient Buildings.

Pickles D, McCraig I and Wood C 2014. *Traditional Windows: their care, repair and upgrading*, Historic England (2014)

Townsend, A and Clark M 1991. *The Repair of Wood Windows*, Technical Pamphlet 13. London: Society for the Protection of Ancient Buildings

Policies

DCLG, 2012, *The National Planning Policy Framework*

DCLG, 2012, *The National Planning Policy Guidance*

Eastbourne Borough Council, 2013, *The Core Strategy Local Plan*

Eastbourne Borough Council, 2003, *The Eastbourne Borough Plan 2001-2011 (Adopted September 2003)*, *saved policies 2007*

Eastbourne Borough Council, 2004, *The Eastbourne Townscape Guide (Supplementary Planning Guidance)*

Illustrations

Fig	Source
1	Timber leaded light - The Park Close Conservation Area
2	Traditional timber sash - Upperton Conservation Area
3	Maintenance metal window https://www.homebuilding.co.uk/2014/11/05/repairing-windows-2/
4	Timber repair https://www.homebuilding.co.uk/2014/11/05/repairing-windows-2/
5	Examples of traditional joinery repair Historic England (2015) <i>Traditional Windows Their Care, Repair and Upgrading</i>
6	Metal repair http://www.tecglass.co.uk/crittall-windows.html
7	Window reveals http://www.theheritagedirectory.co.uk/uploads/articlepix/sash%20window%20history.jpg
8	http://www.lewes.gov.uk/images/windows_sash_row_full.JPG
9	Example of draught proofing strips http://www.buildingconservation.com/articles/sashwindows/sashwindowd4.jpg
10	Drawing of secondary glazing unit (dormer windows at All Saints, Meads) Planning Ref: No 150230
11	Window reveals http://www.theheritagedirectory.co.uk/uploads/articlepix/sash%20window%20history.jpg
12	Traditional timber sash windows (left) and top hung casements in conjunction with fixed lights below (right) - Meads Street, Meads - Date Unknown
13	Window reveals http://www.theheritagedirectory.co.uk/uploads/articlepix/sash%20window%20history.jpg
14	The production of crown glass - http://www.johnsonwindowfilms.com/dealer/articleView.php?ARTICLE_ID=170
	The production of cylinder glass - http://www.idostuff.co.uk/Images/Windows/cylinder%20glass.jpg
15	Horizontal sliding shutter - Bayleaf Farmhouse at the Weald and Downland Open Air Museum http://wien2025.info/?p=139
16	Historic glazing bar profiles (By courtesy of The Brooking Collection)
17	Modern glazing bar profiles - http://www.sashwindowrepair.co.uk/Sash_Window_History/sash_window_history.htm

18	Window reveals http://www.theheritagedirectory.co.uk/uploads/articlepix/sash%20window%20history.jpg
19	Window reveals http://www.theheritagedirectory.co.uk/uploads/articlepix/sash%20window%20history.jpg
20	Example of a Georgian internal bi-folding timber shutter - http://www.buildingconservation.com/articles/sensible-heating/pic_5.jpg
21	Example of traditional handles http://www.buildingconservation.com/articles/windowfurn/windowfurniture.htm
22	Example of traditional cockspur catches http://www.buildingconservation.com/articles/windowfurn/windowfurniture.htm

Contact Historic England

South East

Eastgate Court 195-205 High Street, Guildford GU1 3EH

Tel: 01483-252000

Email: southeast@HistoricEngland.org.uk

Amenity societies

Eastbourne Civic Society, 2 Carlisle Road, Eastbourne

Georgian Group www.georgiangroup.org.uk

Society for the Protection of Ancient Building www.spab.org.uk

Victorian Society www.victoriansociety.org.uk

Twentieth Century Society www.c20society.org.uk